

Dexxo Pro 800 - 1000 RTS

EN Installation manual

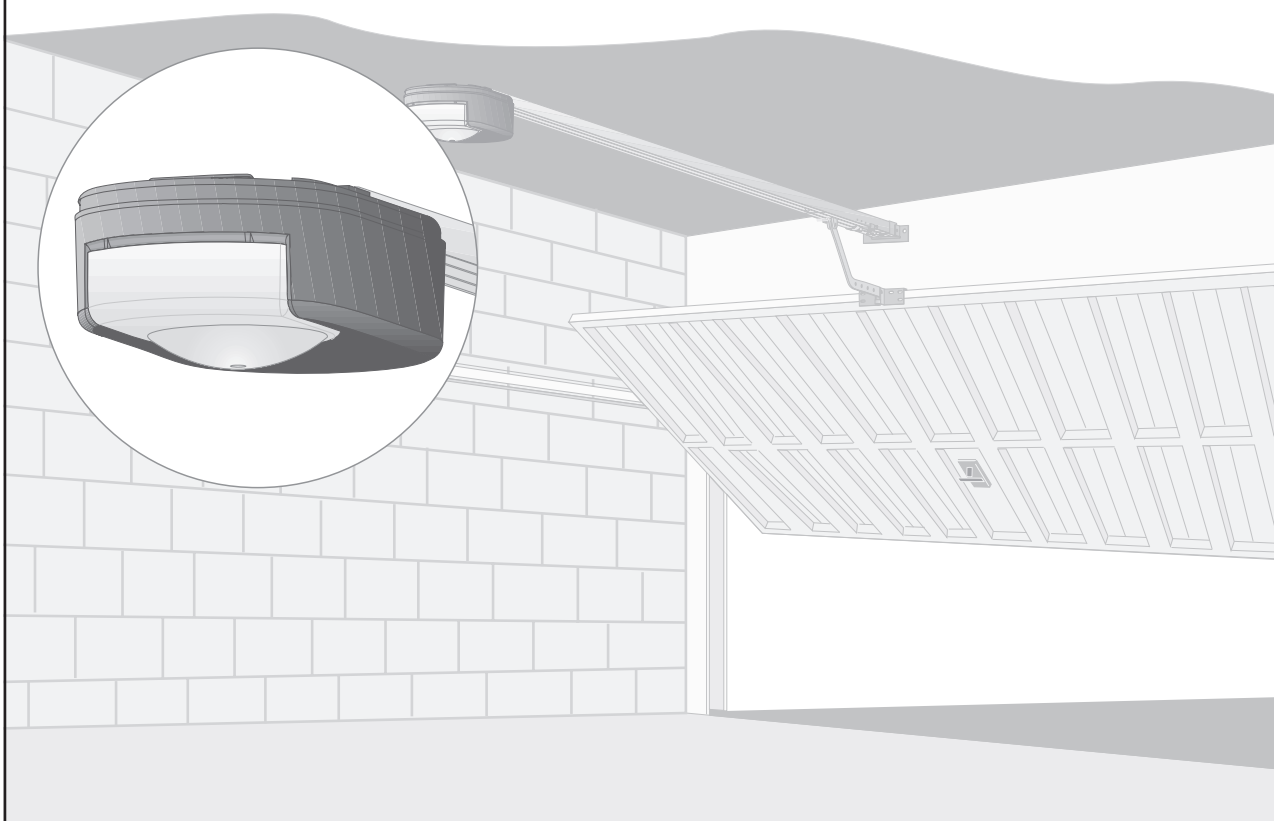

CONTENTS

GENERAL PRESENTATION	2
SAFETY INSTRUCTIONS	2
Caution	2
Safety instructions	2
PRODUCT DESCRIPTION	2
Product components	2
Area of application	2
POINTS TO CHECK PRIOR TO INSTALLATION	3
Preliminary checks	3
Safety instructions	3
INSTALLATION	3
Installation height	3
Detailed description of installation steps	3
PROGRAMMING	5
Programming button description	5
End limit setting and self-learning	5
Memorising the remote controls for operation in «Total opening» mode	5
OPERATING TEST	5
Using the remote controls	5
Obstacle detection function	5
Built in lighting operation	5
CONNECTING PERIPHERALS	6
Description of the various peripherals	6
Electrical connections for the various peripherals	6
SETUP	7
General setup diagram	7
Meanings of the various parameters	7
CLEARING REMOTE CONTROLS AND ALL SETTINGS	9
Clearing remote controls	9
Resetting all settings	9
LOCKING PROGRAMMING	9
REFITTING COVERS	9
TROUBLESHOOTING	9
Operating codes displayed	9
Programming codes displayed	9
Error and failure codes displayed	10
Accessing stored data	10
TECHNICAL SPECIFICATIONS	11
Dimensions	11

GENERAL PRESENTATION

This product complies with the "safety, specific rules for powering vertically opening garage doors in residential use" requirements (standard EN 60335-2.95). When installed in line with these instructions and in compliance with the "Installation Checklist", the product will be compliant with standards EN 13241-1 and EN 12453.

The instructions referred to in the installation manual and instructions for use of this product are designed to prevent damage to property and personal injury along with compliance with the above standards. Failure to comply with these instructions absolves Somfy from any liability resulting from damage that may be caused. Dexxo Pro is a product that must be installed inside the garage with an integrated back-up control system.

Somfy hereby declares that the device is compliant with the essential demands and other relevant requirements of directive 1999/5/CE. A declaration of compliance is available from the web site at www.somfy.com/ce (Dexxo Pro). This product is suitable for use in the European Union and in Switzerland.

SAFETY INSTRUCTIONS

Caution

These are important safety instructions. Always follow the instructions, incorrect installation may lead to serious injury.

Safety instructions

Before installing the motor drive unit, remove all unessential lines or chains and switch off all equipment that is not essential for motorised door operation.

Before installing the motor drive unit, make sure that the door is in good mechanical condition, that it is properly balanced and that it opens and closes correctly.

Locate all control systems at least 1.5 metres above floor level, making sure that they are visible from the entrance to the garage but safe from moving parts.

Position the manual release cord no more than 1.8 metres above floor level.

Where a removable release mechanism is used, we recommend storing it close to the door.

Fix the label describing the manual release procedure close to the release mechanism.

Fix the warning labels describing the hazards of door motion close to any fixed control mechanisms installed and make sure that the labels are clearly visible to the user.

After installation, make sure that the mechanism is correctly adjusted and that the motor drive unit reverses its motion when the door encounters an obstacle that is at least 50 mm from floor level.

After installation, make sure that no part of the door overhangs an area accessible to the public.

After installation, make sure that the motor drive unit inhibits or stops the door opening motion when the door is loaded down with a 20 kg weight attached to a central position of the door's bottom edge.

PRODUCT DESCRIPTION

Product components Fig. 1

Key.	Number	Description	Key.	Number	Description
1	1	Motor head	15	6	HU8 nut
2	1	Motor cover	16	2	Shaft
3	1	Built-in light cover	17	2	Circlips
4	1	Lintel bracket	19	4	Self-shaping Ø 4x8 screw
5	1	Door bracket	20	2	Special screw for plastic Ø 3.5x12
6	2	Ceiling bracket	21a	1	Single part rail
7	2	Motor head bracket	21b	1	Two part rail
8	1	Manual release cord	21b1	1	Sleeve
9	1	Link arm	21b2	8	Self-shaping Ø 4x8 screw
10	1	Travel stop	22	2	HM8 self-locking nut
11	4	Chain retainer pad	23	2	Bracket
12	1	Power cable	24	1	Spacer
13	2	Hex. head M8x16 bolt	25	2	Keygo remote control
14	4	Hex. head M8x12 bolt & washer	26	1	24 V 21 W BA15s socket light bulb

Area of application Fig. 2

Types of doors (Fig.2)

A: Projecting up and over door.

B: Sectional door:

- if the door's **upper profile** is a specific one, use the "sectional door mounting bracket" ref.: 9009390.
- if the door surface exceeds 10 sq. metres, use the "sectional door adapter" ref.: 2400873.

C: Sideways opening sliding door:

- for side wall mounting, use:

- a belt transmission rail
- an "adjustable cranked arm" ref.: 9014481.

- for ceiling mounting, use:

- an "articulated arm" ref.: 9014482.

D: Swinging door. Use the swinging door kit, ref.: 2400459.



E: Semi and non projecting door. Use:

- a high performance transmission rail
- "the semi and non projecting door kit" ref.: 2400458.

Some doors of this type may prove impossible to automate. Contact SOMFY's technical department.

Door dimensions (Fig. 3)

For maximum door heights, the motor travel can be optimised:

- By installing the motor head at a 90° angle (Fig. 7- .
- By fixing the lintel bracket to the ceiling, behind the lintel itself by up to 200 mm (Fig. 5- .
- By cutting the link arm to size.

POINTS TO CHECK PRIOR TO INSTALLATION

Preliminary checks

Check the garage door can be operated manually and runs smoothly. Ensure the door is in good mechanical condition (pulleys, mounts...) and is correctly balanced (spring tension).



Remember that any work performed on door springs may be dangerous.

The structure of your garage (walls, lintel, inside surfaces, cross members, door rails...) are used to mount the Dexxo Pro system. Reinforce them where necessary.

Never splash water onto the system. Never install Dexxo Pro in a location where water may cause damage.

The bottom edge of the door should be fitted with a rubber strip to avoid hard contact and enhance the contact surface.

If the garage door is the only entry point into the garage, fit an external release (external release keylock (ref. 9012961) or an external release (ref. 9012962) and include a back-up battery (ref. 9001001).

If the garage door includes a separate pedestrian door, the door must be fitted with an interlock to prevent garage door movement when the pedestrian door is open (pedestrian door safety kit ref. 2400657).

If the garage door opens on to a public road, install an indicator light, such as a flashing orange light (ref. 9015171).

If the garage door operates in automatic mode, install a photoelectric cell type safety system (ref. 9014994 or ref. 9013647) and a flashing orange light type indicator.

Make sure that the door does not comprise any accessible parts.



Unlocking the door may trigger uncontrolled door movement if the door is not balanced correctly.

Safety instructions

Safety instructions must be complied with throughout the installation process:

- Take off any personal jewellery (bracelet, chain or others) during installation work.
- During drilling and welding work, always wear safety glasses and suitable protection.
- Always use suitable tools.
- Take care when handling the motor drive system.
- Never connect the mains power supply or the battery back-up system before completing the installation process.
- Never use high pressure water systems for cleaning purposes.

INSTALLATION

Installation height

Measure the distance "D" between the door's highest point and the ceiling.

If "D" is between 35 and 200 mm, mount the complete system straight onto the ceiling.

If "D" exceeds 200 mm, mount the complete assembly so that the height "H" falls between 10 and 200 mm.

Detailed description of installation steps

Mounting the lintel bracket and the door bracket (Fig. 5)

When installing the system directly onto the ceiling (flush with the ceiling), the lintel bracket can be mounted on the ceiling, if necessary recessed from the lintel by up to 200 mm max. (Fig. 5- .

Assembling the two part rail (Fig. 6)

[1] [2] [3]. Unfold the two parts of the rail.



Ensure that the chain or belt is not twisted.

[4]. Assemble the two parts of the rail using the sleeve.

[5]. Mount the complete assembly using the eight mounting screws.

[6]. Tighten the nut to tension the chain or belt. The compressed rubber must measure 18 and 20 mm.

The mounting screws must not penetrate the rail (do not drill).

When installing the system directly onto the ceiling, do not use the sleeve mounting screws.

Fitting the rail onto the motor head (Fig. 7)

Fitting the complete assembly onto the garage ceiling (Fig. 8 to 10)

Fitting to the lintel bracket (Fig. 8)

Ceiling mounting

- Flush with the ceiling: mount the system directly onto the ceiling using the rail (Fig. 9).
It is possible to add mounting points at the motor head level (Fig. 9- **i**).
- Hung from the ceiling: two options:
 - mount the system at the motor head (Fig. 10- **a**).
 - mount the system at the rail (Fig. 10- **b**).To add an adjustable intermediate mounting along the rail, or a mounting at a dimension h between 250 mm and 550 mm, use the ceiling mounting kit ref.: 9014462 (Fig. 10- **i**).

Fitting the arm onto the door and the trolley (Fig. 11)

- [1]. Release the trolley using the manual release cord.
- [2]. Bring the trolley up to the door.
- [3]. Attach the arm to the door bracket and the trolley.

Adjusting and fastening the opening travel stop (Fig. 12)

- [1]. Release the trolley from the runner using the manual release mechanism and bring the door to the open position.
Do not open the door fully, but position it so that it does not reach its own travel stop.
- [2]. Slot the travel stop (10) into the rail then turn it by 90°.
- [3]. Position the travel stop against the trolley.
- [4]. Moderately tighten down the mounting screw.



Do not tighten the mounting screw all the way down. Excessive tightening can damage the screw and cause the travel stop not to remain in place.

Fitting the chain retainer pads (Fig. 13)

For chain rails only.

These pads are used to limit spurious noise linked to chain friction within the rail. Position each of the pads in the first hole in the rail after the travel stop. Make sure that the pad is pressed in all the way so that its positioning pin is accessible outside of the rail.

Checking the chain or belt tension (Fig. 14)

The rails are supplied ready tensioned and inspected. If necessary, adjust the tensioning.



The rubber or tension spring must never be fully compressed during operation.

Connecting the mains power supply (Fig. 15)

- [1]. Remove the motor cover and the protective sheet.
- [2]. Fit the light bulb.
- [3]. Connect to the mains supply.



Plug the power cable into a suitable power outlet that complies with electric power requirements. The electric supply must be suitably protected (a fuse or circuit breaker with a 5 A rating) and a residual current device (30 mA).



*An omnipolar disconnection mechanism must be provided for the power supply:
. by using a power cord with a mains splug that can be disconnected, or
. by fitting a switch that ensures a contact separation distance of at least 3 mm for each pole (refer to standard EN60335-1).*







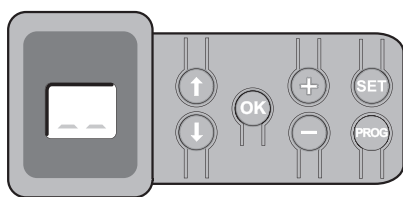

*Make sure that the manual release cord is located at a maximum height of 1.80 metres off the ground.
If necessary, extend the cord.*

PROGRAMMING

Programming button description



-  . Press for 2 s: memorise remote controls
. Press for 7 s: delete remote controls
-  . Press for 0.5 s: call up and exit the setup menu
. Press for 2 s: start learning
. Press for 7 s: clear learning and settings
. Stop learning
-   . Selecting a setting
-   . Modifying a setting value
. Using the forced mode
-  . Start the learning cycle
. Confirm setting selection
. Confirm setting value

End limit setting and self-learning **Fig. 16**



For swinging doors, change the P9 setting before starting self-learning.

- [1]. Press the "SET" button until the light comes on (2 s).
The display shows "S2"
- [2]. Control the motor using the "+" or "-" buttons so that the transmission system runner moves to link up with the trolley and closes the door.
 - Pressing and holding the "-" button closes the door.
Release the "-" button before the motor has time to force against the door.
 - Pressing and holding the "+" button opens the door.
- [3]. Adjust the closed position using the "+" or "-" buttons.
Release the "-" button before the motor has time to force against the door.
- [4]. Press "OK" to validate the closed end limit position and start the self-learning cycle.
The door runs through a complete Open Close cycle.
 - If learning was correct, the display will show "C1".
 - If the learning cycle was not completed correctly, the display will show "S1".

During the learning cycle:

- If the door is moving, pressing any button will stop the movement and interrupt the learning mode.
- If the door is stopped, pressing "SET" once will exit the learning mode.

You can call up the learning mode at any time, even when the learning cycle has already been executed and the display shows "C1".

Memorising the remote controls for operation in «Total opening» mode **Fig. 17**

Up to 32 control channels can be stored.

Running this procedure for a previously stored channel will clear it.

At this stage in the installation process, the Dexxo Pro motor drive unit is ready to run.

OPERATING TEST

Using the remote controls **Fig. 18**

Obstacle detection function **Fig. 19 and 20**

The detection of an obstacle during door opening will stop the door (**Fig. 19**).

The detection of an obstacle during door closure will reopen the door (**Fig. 20**).

Make sure that obstacle detection works when the door encounters an obstacle 50 mm from the ground.

Built in lighting operation

The light will come on every time the motor drive unit is operated. It will go out automatically after one minute once the door stops. This time delay is adjustable (refer to the Setup chapter). Repetitive use which causes the light to stay on continually may result in an automatic cut-off condition triggered by the thermal cut out protection mechanism.

CONNECTING PERIPHERALS

Description of the various peripherals Fig. 21

Key	Description	Key	Description
1	Orange light	7	Pedestrian door safety kit
2	Remote lighting	8	Photoelectric cells
3	Code keypad	9	Reflex type cells
4	Keyswitch	10	Sensor bar
5	Aerial	11	Siren
6	Battery		

Electrical connections for the various peripherals Fig. 21 to 30

Cut the electric power supply to the motor before performing any work on peripherals. If the display remains off after working on the system, check the wiring (for possible short circuits or polarity reversals).

General electrical diagram (Fig. 21)

Photoelectric cells (Fig. 22)

Two types of connections can be made:

A: Standard (without self test): program the setting "P2" = 2.

B: With self test: program the setting "P2" = 1.

This means that an automatic test is conducted to check photoelectric cell operation every time the door operates.

If the test fails, no door movement is possible.

Reflex photoelectric cell (Fig. 23)

With self test: program the setting "P2" = 1.

This means that an automatic test is conducted to check photoelectric cell operation every time the door moves.

If the test fails, no door movement is possible.

Sensor bar (Fig. 24)

With self test: program the setting "P2" = 1.

This is used to perform an automatic test of sensor bar operation every time the door moves.

If the test result is negative, no door movement is possible.



Make sure you have correctly configured parameter "P2" taking into account the photoelectric cells or the sensor bar.

Orange light (Fig. 25)

Program the setting "P1" depending on the required operating mode:

- Without warning before door movement: "P1" = 0.
- With a 2 s warning before door movement: "P1" = 1.

Code keypad (Fig. 26)

Pedestrian door safety kit (Fig. 27)

When the pedestrian door contact is fitted, it must be connected in place of the jumper normally fitted between terminals 5 and 6.



If the pedestrian door contact is removed, the jumper between terminals 5 and 6.

Battery (Fig. 28)

Aerial (Fig. 29)

Remote lighting (Fig. 30)

Class 2 (double insulation) light units that are connected do not require an earth connection.

Various types of lighting can be connected without exceeding a total power consumption of 500 W.

Siren

For more information on connecting the siren, consult the installation manual.

Programme the parameter "Pb" to activate the siren:

- Siren inactive "Pb" = 0.
- Siren active: "Pb" = 1 or "Pb" = 2.

SETUP

General setup diagram Fig. 31

Meanings of the various parameters

Code	Description	Values	Comments
P0	Total operating mode	0: sequential	Each press on the remote control causes the motor to move (initial position: door closed) as per the following cycle: open, stop, close, stop, open...
		1: sequential + timed close	Automatic closure mode operation is only possible if photoelectric cells are fitted, i.e. P2=1 or P2=2.
		2: automatic closure	
		3: automatic closure by cells	In sequential mode with automatic timed close: - the door is closed automatically after the timed delay programmed in parameter "t0", - pressing a button on the remote control interrupts the movement taking place and the timed close. In automatic closure mode: - the door is closed automatically after the timed delay programmed in parameter "t0", - pressing a button on the remote control during opening has no effect, - pressing a button on the remote control during closing causes it to reopen, - pressing a button on the remote control during the timed close restarts the timed delay. After the door is opened, movement in front of the cells (safe closure) will close the door after a short timed delay (fixed at 5 seconds). If there is no movement in front of the cells, the door will close automatically after the timed close programmed in parameter "t0". If there is an obstacle in the cells' detection zone, the door will not close. It will close once the obstacle is removed.
P1	Orange warning light	0: without advance warning 1: with 2 s advance warning	If the garage opens onto a public road, always select with advance warning: P1=1.
P2	Safety input	0: no safety mechanism 1: safety mechanism with self test 2: safety mechanism without self test	If value 0 is selected, the safety input is not taken into account. If value 1 is selected, the system's self test is run at the start of every operating cycle. If value 2 is selected, the safety system runs without a self test: it is essential to test its proper operation every six months.
P3	Obstacle detection sensitivity	0: low sensitivity 1: low sensitivity 2: standard 3: high sensitivity	If this setting is changed, it is essential to run the force measurement sequence at the end of the installation procedure or install a sensor bar.
P4	Partial operating mode	0: sequential	Each press on the remote control causes the motor to move (initial position: door closed) as per the following cycle: open, stop, close, stop, open...
		1: sequential + timed close	Automatic closure mode operation is only possible if photoelectric cells are fitted, i.e. P2=1 or P2=2. In sequential mode with automatic timed close: - the door is closed automatically after the timed delay programmed in parameter "t2", - pressing a button on the remote control interrupts the movement taking place and the timed close.
P5	Closing speed	0: slowest speed: approx. 3.5 cm/s to 9: fastest speed: approx. 18 cm/s By default, 6: approx. 12 cm/s	If this setting is changed, it is essential to run the force measurement sequence at the end of the installation procedure or install a sensor bar.
P6	Partially open position	Storing the position as illustrated in Fig. 33.	
P7	Closure approach speed	0: no slowdown 1: short soft stop 2: long soft stop	P7=0: the door does not slow before closure. P7=1: the door speed slows 20 centimetres before closure. P7=2: the door speed slows 50 centimetres before closure. If this setting is changed, it is essential to run the force measurement sequence at the end of the installation procedure or install a sensor bar.
P8	Opening speed	0: slowest speed: approx. 3.5 cm/s to 9: fastest speed: approx. 18 cm/s	
P9	Choice of operating direction (type of door)	0: direction 1: all types of doors except swinging doors 1: direction 2: swinging doors	If this setting requires modification the end limit setting must be repeated along with self-learning.

Code	Description	Values	Comments
PA	Maintenance required indicator	<i>0: no indication</i> 1: 100 cycles to 99: 9900 cycles (number of cycles = value x 100 cycles)	Once the motor reaches the programmed number of cycles, the integrated light flashes each time the door moves to signal that maintenance is required. To stop the integrated light flashing, either the current value must be confirmed or modified, or the maintenance indicator must be deactivated.
Pb	Detection of forced entry	0: no detection of forced entry 1: obvious forced entry detected 2: less obvious forced entry detected	Detection of forced entry starts operating 30 seconds after the door is closed. If forced entry is detected, the siren sounds for 2 minutes. To stop it, press one of the buttons on the remote control. If photoelectric cells are installed (P2=2), these must be connected to the permanent power supply (refer to the installation manual for the siren).
A0	Safety action prior to opening (safety ADMAP)	0: no effect 1: movement rejected	If value 1 is selected, triggering the safety input will inhibit door opening.
A1	Safety action during closure	1: stop 2: stop + partial re-opening 3: fully reopen	Value 1 is not allowed when using a sensor bar on the safety input.
A2	Obstacle detection action during closure	2: stop + partial re-opening 3: fully reopen	
t0	Total operating mode automatic timed close	0 to 12 (time delay value = value x 10 s) 2: 20 s	
t1	Lighting time delay	0 to 60 (time delay value = value x 10 s) 6: 60 s	
t2	Partial operating mode automatic timed close	0 to 12 (time delay value = value x 10 s) 2: 20 s	

(*Boldface text = default values*)

Programming example: setting the "P7" closure approach speed (Fig. 32)

Setting up a long soft stop function zone "P7" = 2.

Special case: adjusting the position of the door for partial opening (Fig. 33)

Select setting "P6" and validate by pressing "OK".

Move the door to the desired partially open position:

- . Pressing and holding the "-" button will close the door.
- . Pressing and holding the "+" button will open the door.
- . Validate by pressing "OK".
- . Exit the menu with "SET".

Forced mode (Fig. 34)

This function is used to move the door to a specific position:

- . Pressing and holding the "-" button will close the door.
- . Pressing and holding the "+" button will open the door.

Memorising the remote control for operation in «Partial opening» mode (Fig. 35)

Memorising the remote control for controlling remote lighting (Fig. 36)

Memorising a Telis or similar type remote control (Fig. 37)

SPECIAL OPERATION

Refer to the User's Manual page 4.

Adding a remote control without accessing the motor head (see user guide on page 5)

With a Keygo (Fig. 12a)

With a Telis or similar (Fig. 12b)

CLEARING REMOTE CONTROLS AND ALL SETTINGS

Clearing remote controls Fig. 38

Press the "PROG" button until the light blinks (7 s).

This clears all of the remote controls memorised.

Resetting all settings Fig. 39

Press the "SET" button until the light goes out (7 s).

This clears all previously stored settings and returns them to their default values.

LOCKING PROGRAMMING (Fig. 40)

Used to lock the programming settings (end limit setting, self-learning, setup).

Simultaneously press the "SET", "+" and "-" buttons:

- start by pressing "SET".
- pressing "+" and "-" must take place within two seconds.

To access programming mode once again, repeat the same procedure.

REFITTING COVERS (Fig. 41)

Position the aerial and fit the covers.



To ensure proper remote control range, the aerial must be fitted in one of the two positions shown in Figure 41.

TROUBLESHOOTING

Operating codes displayed

Code	Description	Comments
C1	Waiting for a command	
C2	Door opening	
C3	Waiting for the door to close	
C4	Door closing	
C5	Obstacle detection	Displayed during obstacle detection then for 30 s.
C6	Safety input active	Displayed after a movement request or during movement, when the safety input is active. This display is maintained as long as the safety input is active.
C9	Pedestrian door safety contact active	Displayed after a movement request or during movement, when the pedestrian door contact is open. The display is maintained as long as the pedestrian door contact remains open.
Ca	Safety mechanism self test	Displayed during safety mechanism self tests.
Cb	Permanent hardwired control	Indicates that the permanent hardwired control input is activated (contact closed). Commands from radio remote control units are inhibited.
Cd	Working from back-up battery Waiting for a command	

Programming codes displayed

Code	Description	Comments
S1	Awaiting setting	Pressing the "SET" button for 2 s starts the learning mode.
S2	Learning mode	Pressing the "OK" button starts the learning cycle: the S2 display blinks during the entire cycle. Pressing the "+" or "-" buttons will control the motor in forced mode.
F0	Awaiting remote control memorisation for operation in total opening	Pressing a button on the remote control allocates this button to the motor total opening control. Pressing "PROG" once more switches to "awaiting remote control memorisation for operation in partial opening: F1" mode.
F1	Awaiting remote control memorisation for operation in partial opening	Pressing a button on the remote control allocates this button to the motor partial opening control. Pressing "PROG" once more switches to "awaiting remotely controlled lighting memorisation: F2" mode
F2	Awaiting remotely controlled lighting memorisation	Pressing a button on the remote control allocates this button to the remotely controlled lighting control. Pressing "PROG" once more switches to "awaiting remote control memorisation for operation in total opening: F0" mode.

Error and failure codes displayed

Code	Description	Comments	Action required?
E2	Safety input always active	Displayed when the safety input remains active for more than three minutes.	Check that there is no obstacle triggering cell or sensor bar detection. Check that "P2" is setup correctly depending on the devices connected to the safety input. Check safety device wiring. When photoelectric cells are used, check their proper alignment.
E4	Safety mechanism self test fault	The safety device self test failed	Check that "P2" is setup correctly depending on the devices connected to the safety input. Check safety device wiring. When photoelectric cells are used, check their proper alignment.
Eb Ec	Other faults and failure conditions	These codes correspond to various electronic circuit board failures.	Cut the power supply (mains & battery back-up), wait for a few minutes then re-connect the power supply. Perform a learning cycle. If the fault persists, contact Somfy Technical Support.
H1	Detection of forced entry	Displayed when an action occurs from outside the garage (read by reinjection of power)	Press a button on the memorised remote control to stop the siren. Start a complete opening and closing cycle.
H2	Detection of forced entry	Displayed when an action occurs from outside the garage (read by optical encoder)	Press a button on the memorised remote control to stop the siren. Start a complete opening and closing cycle.
CC	Maintenance is required	Displayed when maintenance is required on the installation. The number of cycles programmed in parameter "PA" has been reached.	Confirm or modify the current "PA" value, or deactivate the "Maintenance required indicator" function.

Accessing stored data

To access stored data, select the "Ud" setting then press "OK" as shown in Fig. 31.

Data	Description
U0	Total cycle counter: tens and units
U1	Total cycle counter: thousands and hundreds
U2	Total cycle counter: hundreds of thousands
U3	Cycle counter with obstacle detection: tens and units
U4	Cycle counter with obstacle detection: thousands
U5	Number of control channels memorised
d0 to d9	Log of the last ten faults
dd	Clears the fault log: press "OK" for 7 s (Fig.31).

TECHNICAL SPECIFICATIONS

		Dexxo Pro 800 RTS	Dexxo Pro 1000 RTS
BASIC TECHNICAL CHARACTERISTICS			
Mains supply		230 V - 50 Hz	
Max. power consumption	Standby-Operation	5 W - 600 W (with 500 W remote lighting)	
Traction force	Peak force	800 N	1000 N
	Starting force (1)	650 N	800 N
Use		20 cycles max. per day with a standard rail - 50 cycles max. per day with a high performance rail tested for 36,500 cycles with a standard rail and 90,000 cycles with a high performance rail	
Number of Opening/Closing cycles per day			
Max. speed		18 cm/s	
Programming interface		7 buttons - 2 character LCD display	
Operating temperature		- 20 ° C / + 60 ° C - indoor dry - IP 20	
Travel end limits		Mechanical stopper at opening Memorized end limit position at closing	
Electrical insulation		Class 2: double insulation <input type="checkbox"/>	
Built in lighting		24 V / 21 W ; BA15s socket	
Somfy radio frequency		RTS 433.42 MHz	
Number of channels that can be memorised		32	
CONNECTIONS			
Safety input	Type	Dry contact: NC	
	Compatibility	Photoelectric TX/RX cells - Reflex cell - Sensor strip with dry contact output	
Pedestrian door safety input		Dry contact: NC	
Wired control input		Dry contact: NO	
Remote lighting output		230 V - 500 W - class 2 <input type="checkbox"/>	
Orange light output		24 V - 15 W with built in flashing control	
24 V controlled power supply output		Yes: for possible photoelectric TX/RX cell self-test	
Safety input test output		Yes: for possible reflex cell or sensor strip self-test	
Accessory power supply output		24 V - 500 mA max	
Remote aerial input		Yes: RTS aerial compatible (Réf. 2400472)	
Backup battery input	Autonomy	Yes: battery pack compatible (Réf. 9001001) 24 hours; 5 to 10 cycles depending on door Charge time: 48 hours	
OPERATION			
Forced operation mode		By pressing and holding the motor control button	
Independent lighting control		Yes for remote lighting	
Lighting time delay (after movement)		Programmable : 60 s to 600 s	
Automatic closing mode		Yes: programmable closing time delay from 10 to 120 s	
Orange light pre-warning		Programmable: with or without prior warning (duration set to 2 s)	
Safety input operation	While closing Before opening (Dangerous Movement Area Accessible to the Public)	Programmable: Stop - Partial re-opening - Full reopening Programmable: no effect or motion refused	
Built-in obstacle detection		Adjustable sensitivity: 4 levels	
Operation when an obstacle is detected		Programmable : partial re-opening or full reopening	
Preset partial opening command		Yes can be selected: adjustable partial opening position	
Progressive start up		Yes	
Opening speed		Programmable from 3.5 cm/s to 18 cm/s: 10 possible values	
Closing speed		Programmable from 3.5 cm/s to 18 cm/s: 10 possible values	
Closure approach speed		Programmable: does not slow down, short slowdown zone (30 cm), long slowdown zone (50 cm)	
Troubleshooting		Recording and accessing data: Cycle counter, cycle counter with obstacle detection, number of radio channels stored, history of the last ten defects recorded.	

(1) Maximum load for motor to start and drive door for at least 5 cm (according to RAL-GZ definition).

Dimensions

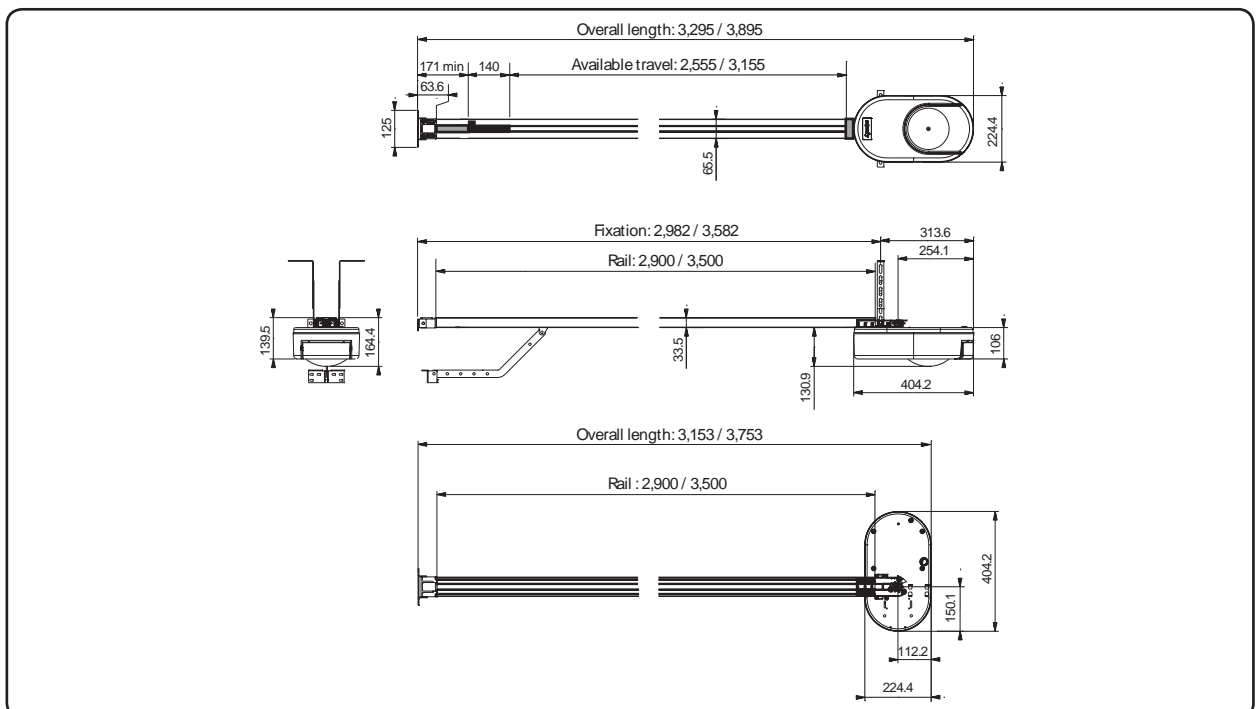

**Listes des filiales / Somfy weltweit / Lists of subsidiaries
Lista oddziałów / Elenco delle filiali / Lijst van filialen**

United Kingdom : Somfy LTD
+44 (0) 113 391 3030



PATENTS AND DESIGN PATENTS PENDING FOR SOME COUNTRIES (e.g. : US)
Somfy SAS, capital 20.000.000 Euros, RCS Annecy 303.970.230 - 05/2013

